



Pro1 Technologies

P.O. Box 3377
 Springfield, MO 65808-3377
 Toll Free : 888-776-1427
 Web: www.pro1iaq.com
 Hours of Operation: M-F 9AM - 6PM EST

T751i



Thermostat Application Guide

Description	
Gas or Oil Heat	Yes
Electric Furnace	Yes
Heat Pump (No Aux. or Emergency Heat)	Yes
Heat Pump (With Aux. or Emergency Heat)	Yes
Multi-Stage Systems	Yes
Heat Only Systems	Yes
Cool Only Systems	Yes
Millivolt	No

Power Type

Hardwire (24V Common Wire)

A trained, experienced technician must install this product.

Carefully read these instructions. You could damage this product or cause a hazardous condition if you fail to follow these instructions.

Una version en espanol de este manual se puede descargar en la pagina web de la compania.

Wall Installation

The thermostat should be installed approximately 4 to 5 feet above the floor. Select an area with average temperature and good air circulation. Pick an installation location that is easy for the user to access. The temperature of the location should be representative of the building.

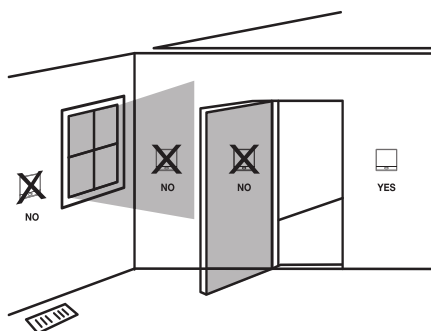

Do not install thermostat in locations:

- Close to hot or cold air ducts
- That are in direct sunlight
- With an outside wall behind the thermostat
- In areas that do not require conditioning
- Where there are dead spots or drafts (in corners or behind doors)
- Where there might be concealed chimneys or pipes

Table of Contents

Page

Installation Tips	2
Thermostat Quick Reference	3
Subbase Installation	4
Wiring	5-7
Technician Setup	8-12
WiFi Setup	13
Specifications	14

WiFi

Frequency Range.....2.4 Ghz ISM radio band
 WiFi Module.....Supporting 802.11 B/G/N Standards

Removing The Private Label Badge

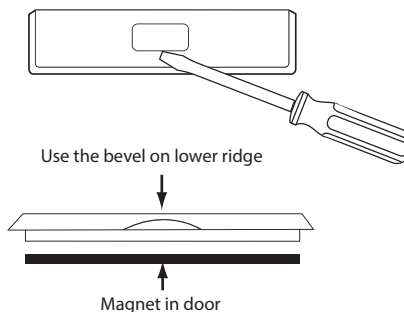

Gently slide a screwdriver into the bottom edge of the badge. Gently turn the screwdriver counter clockwise. The badge is held on by a magnet in the well of the battery door. The badge should pry off easily. **DO NOT USE FORCE.**

All of our thermostats use the same universal magnetic badge. Visit the company website to learn more about our free private label program.

1 © U.S. Registered Trademark. Patents pending
 Copyright ©2024 All Rights Reserved.

Rev. 2403

THE POWER OF PARTNERSHIP

Thermostat Quick Reference

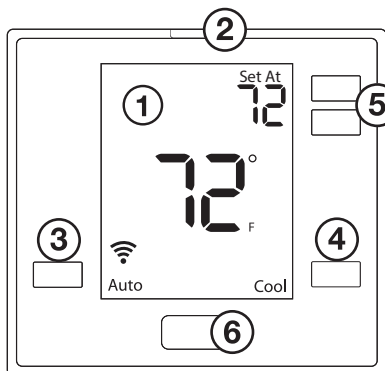

- 1 LCD Display
- 2 Glow in the dark light button
- 3 Fan Button
- 4 System Button
- 5 Temperature Setpoint Buttons
- 6 Private Label Badge

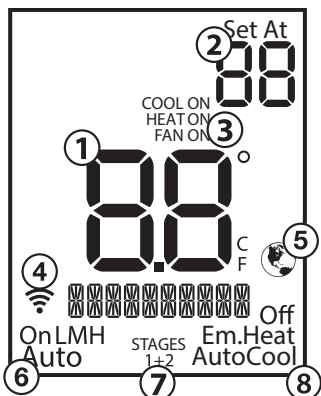

- 1 Indicates the current room temperature
- 2 **Setpoint:** Displays the selected setpoint temperature.
- 3 **System Operation Indicators:** The COOL ON, HEAT ON or FAN ON will display when the COOL, HEAT, or FAN is on. **The compressor delay feature is active if these are flashing.**
- 4 **WiFi Indicator:** Shown when connected to WiFi.
- 5 **Globe:** Globe is displayed if an energy efficient setpoint temperature has been selected.
- 6 **Fan:** Indicates the current fan setting.
- 7 **Stages:** 1 will appear in the display when the first stage of heat or cool is on. +2 will appear for the second stage of heat.
- 8 **System:** Indicates current system mode setting.

Subbase Installation

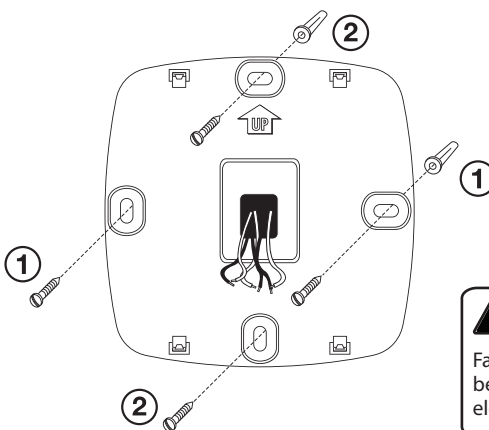

- 1 **Horizontal Mount**
For horizontal mount put one screw on the left and one screw on the right.
- 2 **Vertical Mount**
For vertical mount put one screw on the top and one screw on the bottom.

⚠ Electrical Hazard
 Failure to disconnect the power before beginning to install this product can cause electrical shock or equipment damage.

NOTE: To ensure a solid fit between the thermostat and subbase:
 1. Mount subbase on a flat wall.
 2. Use provided screws.
 3. Ensure drywall anchors are flush with wall.
 4. Push wires into wall.

⚠ Mercury Notice
 All of our products are mercury free. However, if the product you are replacing contains mercury, dispose of it properly. Your local waste management authority can give you instructions on recycling and proper disposal.

Mount Thermostat

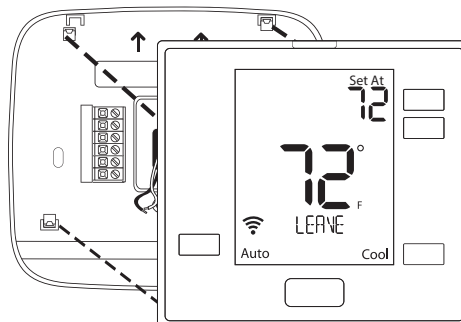

Align the 4 tabs on the subbase with corresponding slots on the back of the thermostat, then push gently until the thermostat snaps in place.

Wiring

- 1 Power Supply
- 2 Factory-installed jumper, remove only when installing on 2-transformer system.
- 3 Use either O or B terminals for changeover valve.
- 4 A 24 VAC 500mA common connection is required with this thermostat.

Typical Cool-Only System With Fan

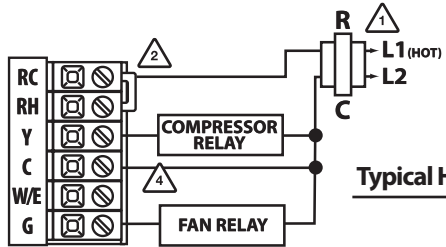

Typical Heat Only System With Fan

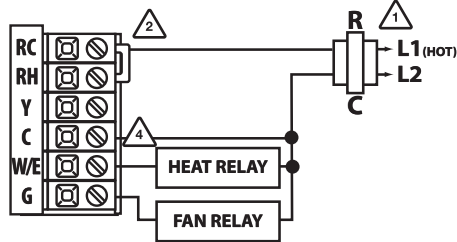

Typical 1H/1C or 2H/2C System: 1 Transformer

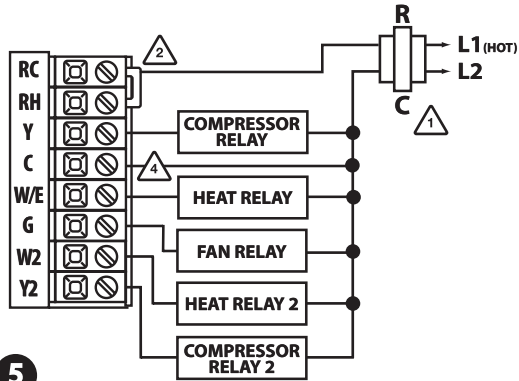

5

Wiring

Typical 1H/1C or 2H/2C System: 2 Transformer

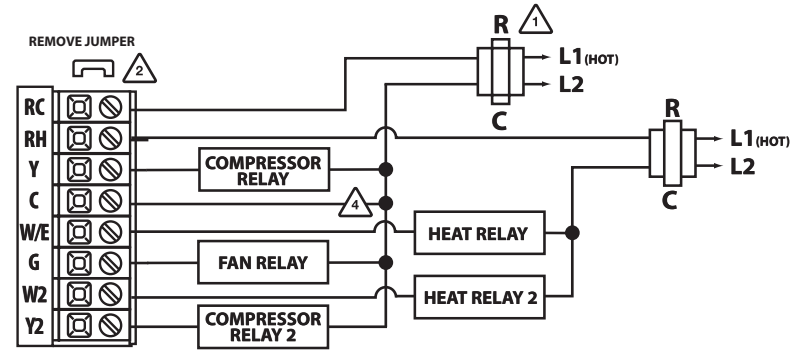

Typical 4H/2C or 2H/1C Heat Pump System

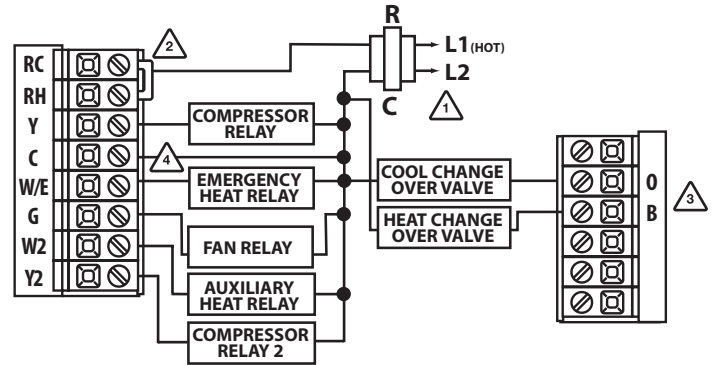

Note: Devices such as a float switch that mechanically break circuits should be installed so that they break the control wire (Y) not the power (R). Interrupting the power circuit will shut off power to the thermostat completely and not allow it to operate.



Installation Tip Max Torque = 6in-lbs.

Do not overtighten terminal block screws, as this can damage the terminal block. A damaged terminal block can keep the thermostat from fitting on the subbase correctly or cause system operation issues.

6

Wiring

Replacement Thermostat Wiring

- If you are replacing a thermostat, make note of the terminal connections on the thermostat that is being replaced. In some cases the wiring connections will not be color coded. For example, the green wire may not be connected to the G terminal.
- Loosen the terminal block screws. Insert wires then retighten terminal block screws.
- Place nonflammable insulation into wall opening to prevent drafts.
- This thermostat requires a 24V common wire to the C terminal.



Caution: Electrical Hazard

Failure to disconnect the power before beginning to install this product can cause electrical shock or equipment damage.



Warning:

All components of the control system and the thermostat installation must conform to Class II circuits per the NEC Code.

Wiring Chart

Terminal	2 Heat 2 Cool Conventional System	2 Heat 1 Cool Heat Pump System	4 Heat 2 Cool Heat Pump System
RC	Transformer power (cooling)	Transformer power (cooling)	Transformer power (cooling)
RH	Transformer power (heating)	Transformer power (heating)	Transformer power (heating)
C	Transformer common	Transformer common	Transformer common
B	Reverse Valve / Configurable Terminal	Reverse Valve / Configurable Terminal	Reverse Valve / Configurable Terminal
O	Reverse Valve / Configurable Terminal	Reverse Valve / Configurable Terminal	Reverse Valve / Configurable Terminal
G	Fan relay	Fan relay	Fan relay
W/E	First stage of heat	First stage of emergency heat	First stage of auxiliary heat
W2	Second stage of heat	Auxiliary heat relay, second stage of heat	Second stage of auxiliary heat
Y	First stage of cool	First stage of heat & cool	First stage of heat & cool
Y2	Second stage of cool	N/A	Second stage of cool & second stage of heat

7

Technician Setup Menu

Technician Setup Menu

This thermostat has a technician setup menu for easy installer configuration. To set up the thermostat for your particular application:

- Press and hold the + and - buttons for 3 seconds.
- Press and hold the TECH button for 3 seconds.
- Configure the installer options as desired using the table below. Use the + or - buttons to change settings and the lower left and right buttons to move from one step to another.
- To exit tech setup: press and hold the + and - buttons for 3 seconds, or wait 60 seconds.













Tech Setup Steps	LCD Will Show	Adjustment Options	Default
Room Temperature Calibration	0 CALIBRATE	You can adjust the room temperature display to read up to 4° above or below the factory calibrated reading.	0°F
Compressor Short Cycle Delay	07 COMP DELAY	Selecting "ON" will not allow the compressor to be turned on for 5 minutes after the last time the compressor was on. Select "OFF" to remove this delay. Use the [+/-] and [-] buttons to change the setting.	ON
Cooling Swing	0.5 COOL SWING	The cooling swing setting is adjustable from 0.2° to 2°. For example: A swing setting of 0.5° will turn the cooling on at approximately 0.5° above the setpoint and turn the cooling off at approximately 0.5° below the setpoint.	0.5°

Swing Setting Tip

Temperature swing, sometimes called differential or cycle rate, can be customized for this individual application. For most applications choose a swing setting that is as long as possible without making the occupants uncomfortable.

8











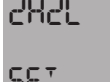



Technician Setup Menu

Tech Settings	LCD Will Show	Adjustment Options	Default
Heating Swing The swing setting often called "cycle rate," "differential," or "anticipation" is adjustable. A smaller swing setting will cause more frequent cycles and a larger swing setting will cause fewer cycles.	 HERT SWING	The heating swing setting is adjustable from 0.2° to 2°. For example: A swing setting of 0.5° will turn the heating on at approximately 0.5° below the setpoint and turn the heating off at 0.5° above the setpoint.	0.8°
PTAC Mode This setting allows the thermostat to operate a PTAC. This will allow for multiple fan speeds selectable in the next two tech settings.	 PTAC MODE	Use the  and  buttons to select ON/OFF.	OFF
PTAC Fan Speeds This setting allows you to choose the number of fan speeds the thermostat will control. (Only displayed if PTAC mode is ON)	 FAN SPEEDS	Use the  and  buttons to select , 2 or 3. 1. Speeds: ON, Auto 2. Speeds: Low, High, Auto 3. Speeds: Low, Med, High, Auto	2
PTAC Medium Fan Speed Terminal This setting will select the terminal for medium fan speed operations. The selected terminal cannot be used for reversing valve operations when heat pump is enabled. (Only displayed if PTAC mode is ON and PTAC fan speeds is set to 3)	 M FAN TERM	Use the  and  buttons to select O/B terminals.	0
Heat Pump When turned on the thermostat will operate a heat pump. EM. Heat will show as an option in the system switch tech setting. Use the  and  button to adjust.	 HEAT PUMP	OFF configures the thermostat for conventional systems. ON configures the thermostat for heat pump systems.	OFF















Swing Setting Tip

The second stage will turn on at 2x the swing setting. The second stage will turn off when 1x the swing is reached. For example, if the swing setting is .5 degrees for heating and the thermostat is set at 70°F, the first stage will turn on at approximately 69.5°F. The second stage will turn on at 69°F. The second stage will turn off at 69.5°F and the first will turn off at 70.5°F. If the third stage is used, it will turn on at 68.5°F and turn off at approximately 69°F.













Technician Setup Menu

Tech Settings	LCD Will Show	Adjustment Options	Default
System Stages This setting allows you to select the number of heat and cool stages.	 SET STAGES	Use the  and  buttons to select 1H/1C, 1H/2C, 2H/1C, 2H/2C, 3H/1C, 3H/2C, 4H/2C.	2H/2C
System Set You can configure the system switch for the particular application. Heat - Off - Cool, Heat - Off, Cool - Off, Heat - Off - Cool - Auto. Note: Emergency Heat is available in heat pump mode only.	 SYSTEM SET	Use the  or  buttons until the desired application is flashing. AUTO = (Auto Changeover)	HC
Electric or Gas Fan Operation Select GAS to have the system control the fan during a call for heat, select Electric to have the thermostat control the fan during a call for heat. (Only displayed if heat pump is set to OFF)	 FAN OPER	Use  and  buttons to change the setting.	GAS
Dual Fuel Auxiliary For Heat Pump This setting allows the system to run Gas, Oil, Propane or any other types of auxiliary heat. The thermostat will default to electric auxiliary heat in heat pump applications. (Only displayed if heat pump is set to ON)	 DUAL FUEL	Use the  and  buttons to select ON/OFF.	OFF
Satisfy Setpoint Staging This feature allows the thermostat to keep multiple stages of heat or cool energized until the setpoint is satisfied. (Only displayed if there are more than one stage of heat or cool)	 SATISFY SP	Use the  or  buttons to turn on or off.	OFF

Technician Setup Menu

Tech Settings	LCD Will Show	Adjustment Options	Default
Staging Delay This feature allows a delay to occur if an additional stage is needed. This allows the previous stage extra time to satisfy the setpoint. (Only displayed if there are more than one stage of heat or cool)	 STG DELAY	Use the  or  key to select OFF, 5, 10, 15, 30, 45, 60, or 90 minutes.	OFF
Minimum Compressor On Time This feature allows the installer to select the minimum run time for the compressor. For example, a setting of 4 will force the compressor to run for at least 4 minutes every time the compressor turns on, regardless of the room temperature.	 MIN COMP	You can set the minimum compressor run time to "OFF", "3", "4", or "5" minutes. If 3, 4 or 5 is selected, the compressor will run for at least the selected time before turning off. Use the  and  buttons to change the setting.	OFF
Cooling Fan Delay The cooling fan delay setting will delay the fan from coming on in cool mode and keep it running after the compressor shuts off for a short time to save energy in some systems.	 COOL DELAY	You can set the cooling fan delay to OFF, 10, 30, 60 or 90 seconds. If 10, 30, 60, or 90 is selected the fan will not turn on for that many seconds when there is a call for cool and will run for that many seconds after satisfying a call for cool.	OFF
Heat Setpoint Limit This feature allows you to set a maximum heating setpoint limit. The setpoint temperature cannot be raised above this value.	 HEAT LIMIT	Use the  or  key to select the maximum heat setpoint and the minimum cooling setpoint.	90°F
Cool Setpoint Limit This feature allows you to set a minimum cooling setpoint limit. The setpoint temperature cannot be lowered below this value.	 COOL LIMIT	Use the  or  key to select the minimum cooling setpoint.	50°F
°F or °C This feature allows you to display temperatures in either Fahrenheit or Celsius.	 F OR C	°F for Fahrenheit °C for Celsius	°F

Technician Setup Menu

Tech Settings	LCD Will Show	Adjustment Options	Default
Display Light The display light can be configured to stay on all the time or turn on when any key is pressed. There are LOW and HIGH selections for continuous ON selection.	 DISP LIGHT	Use the  and  buttons to select OFF, LOW, or HIGH. OF configures the display light to come on when the light key or any button is pressed. LO configures the display light to stay on at a low intensity constantly. When a button is pressed, the display light will transition to high intensity. HI configures the display light to remain on at high intensity all the time.	LO
Program Options You can configure this thermostat to have a programmable schedule ON or OFF.	 PROGRAM	Use the  and  button to select ON for programmable or OFF for non-programmable.	ON
12 or 24 Hour Clock You can select either a 12 or 24 hour clock setting.	 CLOCK SET	Use the  or  key to select 12 or 24 hour clock.	12
Pro Recovery (Only displayed if Program Option is set to "ON") This feature will start heating and cooling early to bring the building temperature to its programmed setpoint by the beginning of the WAKE and RETURN time periods.	 PRO RECOV	Use the  or  key to select on or off.	ON

These tech settings will only appear once the thermostat has been connected to the App.

The following WIFI Technician steps are intended for viewing information and resetting your WIFI connection. They are not typically necessary for installation or initial setup.

1. Press and hold the + and – buttons together for 3 seconds.
2. Press and hold the WIFI Button on the lower left.
3. Use the + or - buttons to change settings and the lower left and right buttons to move from one step to another. To exit tech setup: press and hold the + and - buttons for 3 seconds or wait 60 seconds.

Tech Setup Steps	LCD Will Show	Adjustment Options	Default
WIFI SSID	SS ID F4D11S00	N/A	N/A
Firmware	F4 9909 14	N/A	N/A
Reset WIFI	YES WIFI RESET	Hold the  button for three seconds and you will be returned to the home screen. WIFI RESET will not be displayed.	YES

WIFI Reset Process

This step resets the WIFI connection when needed for applications like replacing WIFI routers, changing networks, or any other time you might need to disconnect and reconnect your thermostat to a local WIFI network.

1. Enter the WIFI Menu and cycle through the steps until you get to the **RESET WIFI** setting.
2. Hold the + button for three seconds.
3. You will now be automatically returned to the home screen and “WIFI RESET” network will be displayed indicating the thermostat is no longer connected to the local WIFI network. You will need to recommission the thermostat to control your system from the PRO1 Connect App.

Specifications

The display range of temperature ... 41°F to 95°F (5°C to 35°C)
 The control range of temperature... 44°F to 90°F (7°C to 32°C)
 Load Rating..... 1 amp per terminal, 1.5 amp maximum all terminals combined
 Swing (cycle rate or differential) Heating is adjustable from 0.2° to 2.0°
 Cooling is adjustable from 0.2° to 2.0°
 Power source 18 to 30 VAC, NEC Class II, 50/60 Hz for hardwire
 Operating ambient 32°F to +105°F (0°C to +41°C)
 Operating humidity 90% non-condensing maximum
 Dimensions of thermostat 4.7” W x 4.3” H x 0.9” D

WIFI

Frequency Range..... 2.4 Ghz ISM radio band
 WIFI Module..... Supporting 802.11 B/G/N Standards